



DECOMASTER

INTERIOR DECOR



**DUROPROFILE  
COLLECTION**

IMPACT-RESISTANT POLYMER



QR-CODE  
TO THE PRODUCT  
CATALOGUE

DECOMASTER is a manufacturer of high-quality and stylish interior decor. We have been working for more than 25 years. Our products are highly variable, fashionable and functional. Smart design and high technology assure strong and water-resistant products.

#### DECOMASTER TODAY

- The leading manufacture in Russia
- A wide range of interior moldings, cornice and floor skirting
- Our superior quality products are fully impact- and water-resistant.
- The products are paintable or have natural textures and colors
- Sustainability and eco-friendly.

#### DUROPROFILE COLLECTION

A wide range of interior moldings, cornice and floor skirting. All of DUROPROFILE products are ready for paint. All products have a stable geometry, clear lines and elegant design. The collection has many modern designs for indirect lighting.

All products meet international quality standards.

**DUROPROFILE ADVANTAGES:**

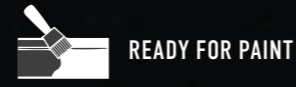
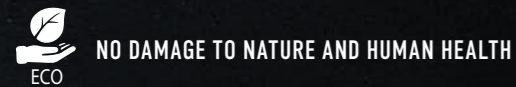
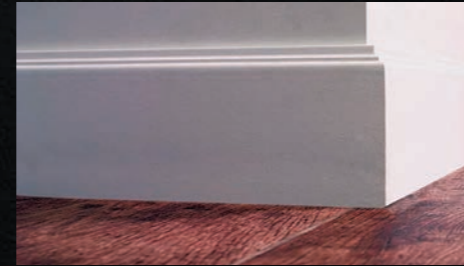

We are proud of our ability to create premium quality products with five-year warranty.  
 Our products are good for all interior styles from Classic to Modern ones.  
 We offer our customers complete smart interior solutions worldwide.  
 Our mission is to supply exclusive premium quality interior decorations at a competitive price in a reliable manner.

Cornices .....	6	Floor skirting styles .....	50
Angle moldings .....	12	Moldings for stretch ceilings .....	51
Wall moldings .....	14	Moldings for indirect lighting .....	53
Floor skirtings .....	24	Example of doorways design .....	54
Cornices with pattern .....	30	Installation manual .....	56
Wall moldings with pattern .....	34	Ends of the floor skirtings .....	58
Ready-made collections with pattern .....	42	DECOMASTER adhesive .....	59
Multipurpose use .....	48	Item list .....	61



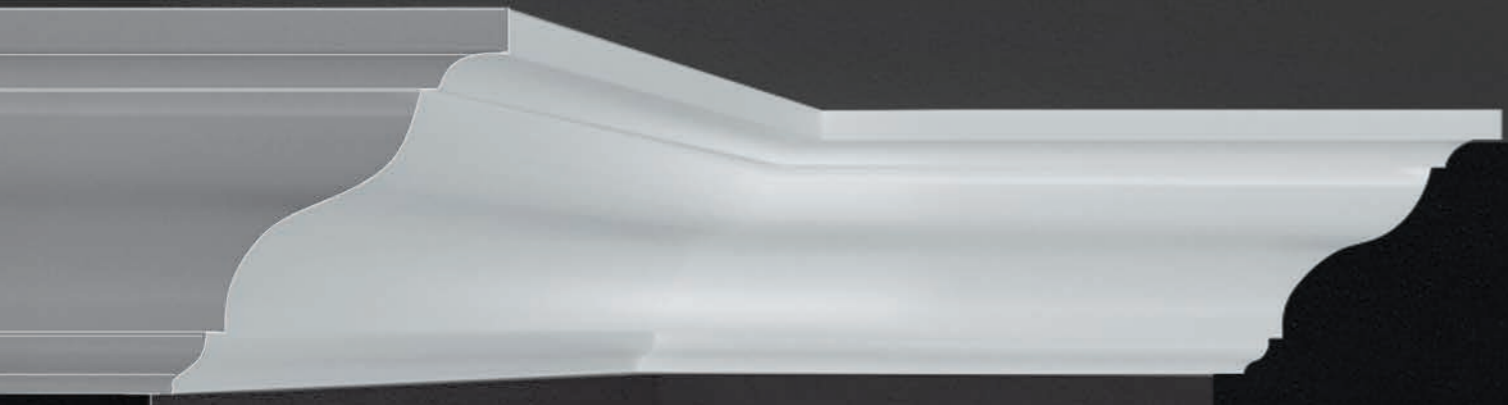
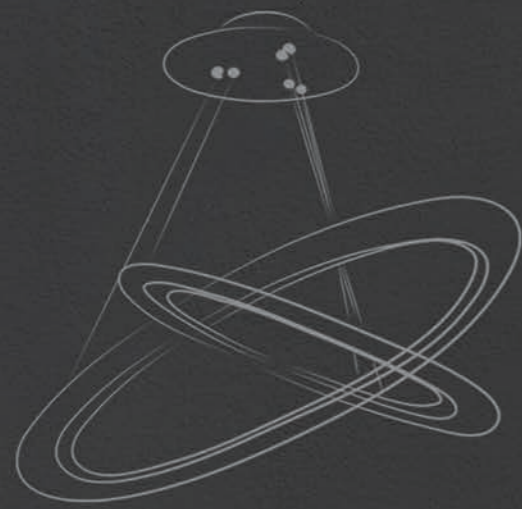

# DUROPROFILE COLLECTION CORNICES

D133



D132

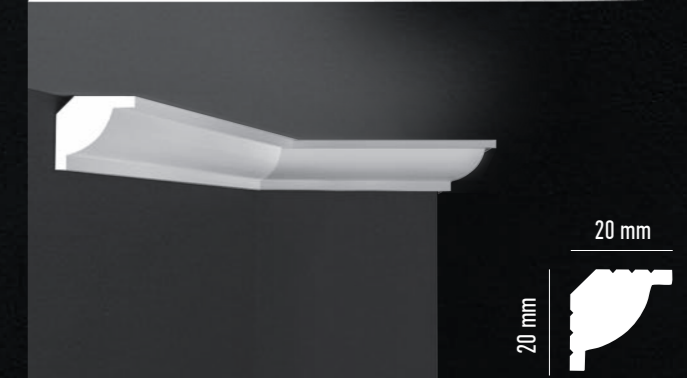

D111

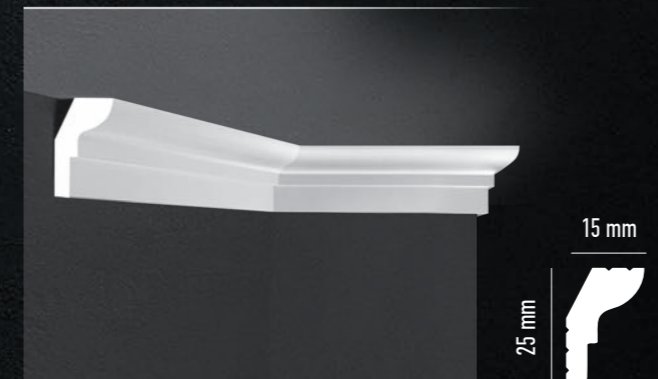

D008

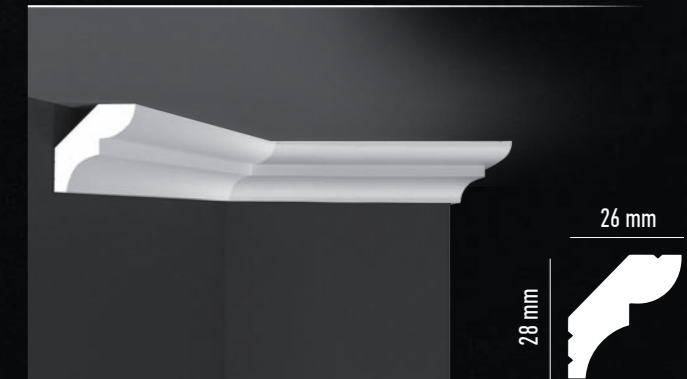

D115

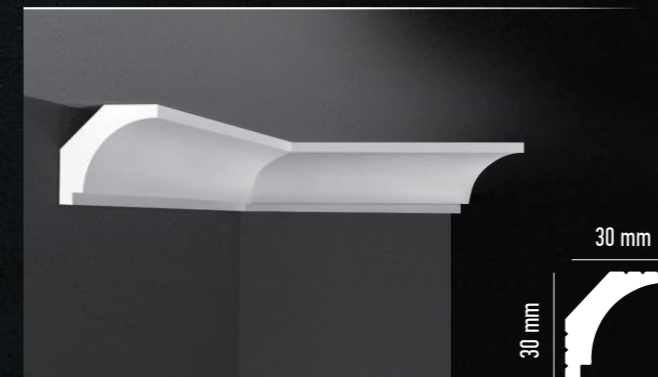

D151



D109

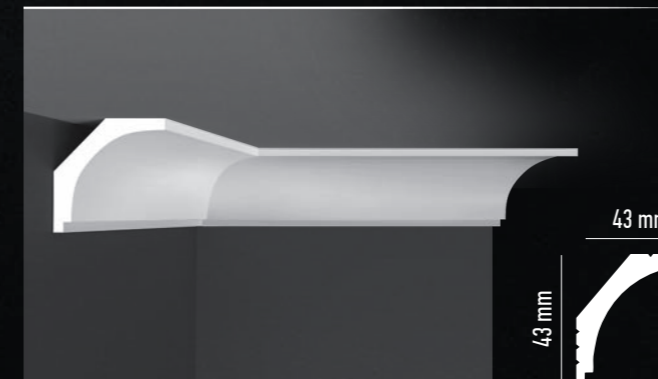

D110





Cornice D124

Molding D130

Length 2000 mm

D112

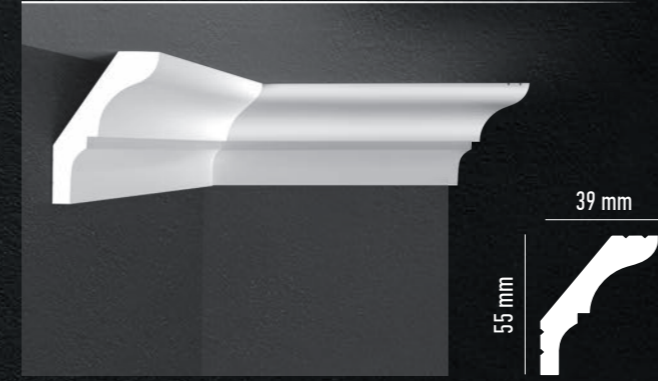

D108

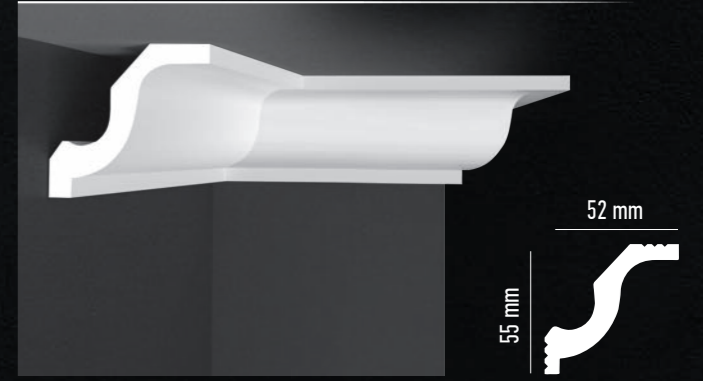

D212



D390



D148

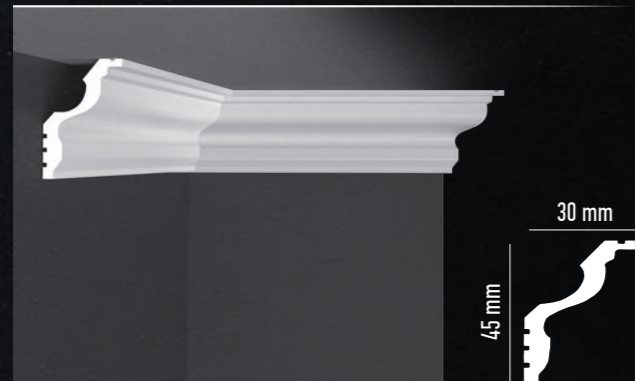

D506

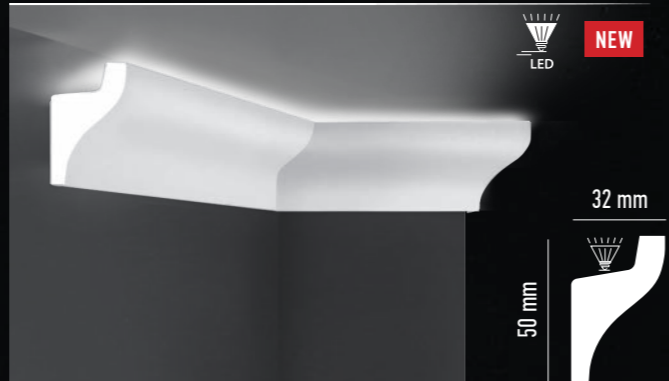

D124



D155

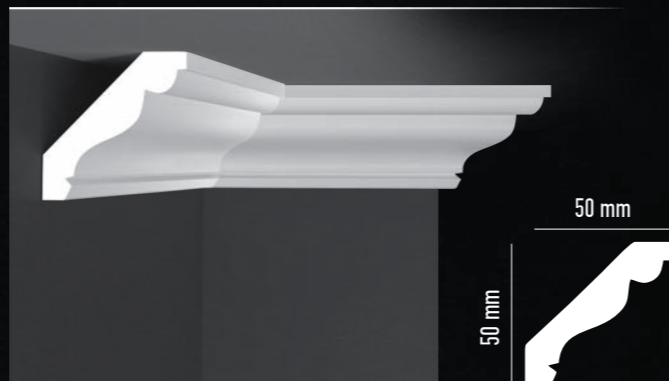

Molding D130

D506

Cornice D506

**D100**

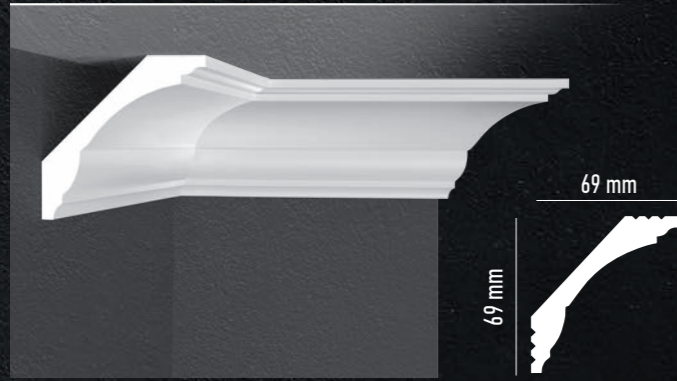

**D502**

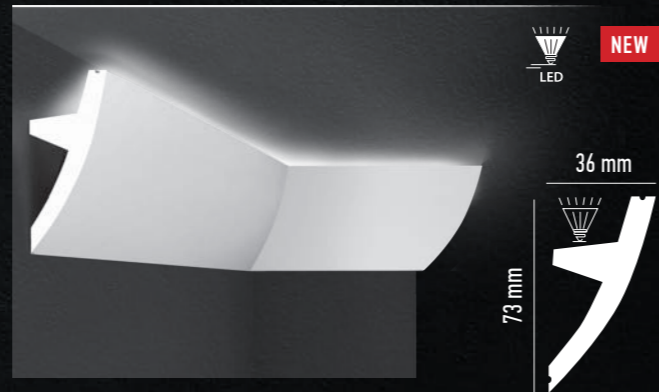

**D501**



**D154**

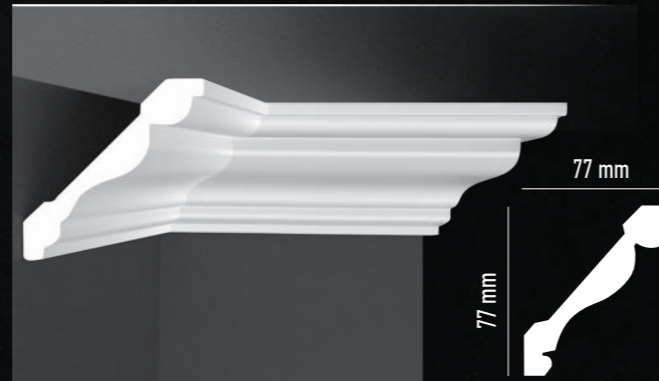

Cornices for indirect lighting with modern designs. Fix only to the walls. The cornices D501, D502, D506 have metallic coating, which avoids from transillumination if correct fixing. The cornices are of multipurpose use for ceiling, walls and floor.

Installation of LED strips

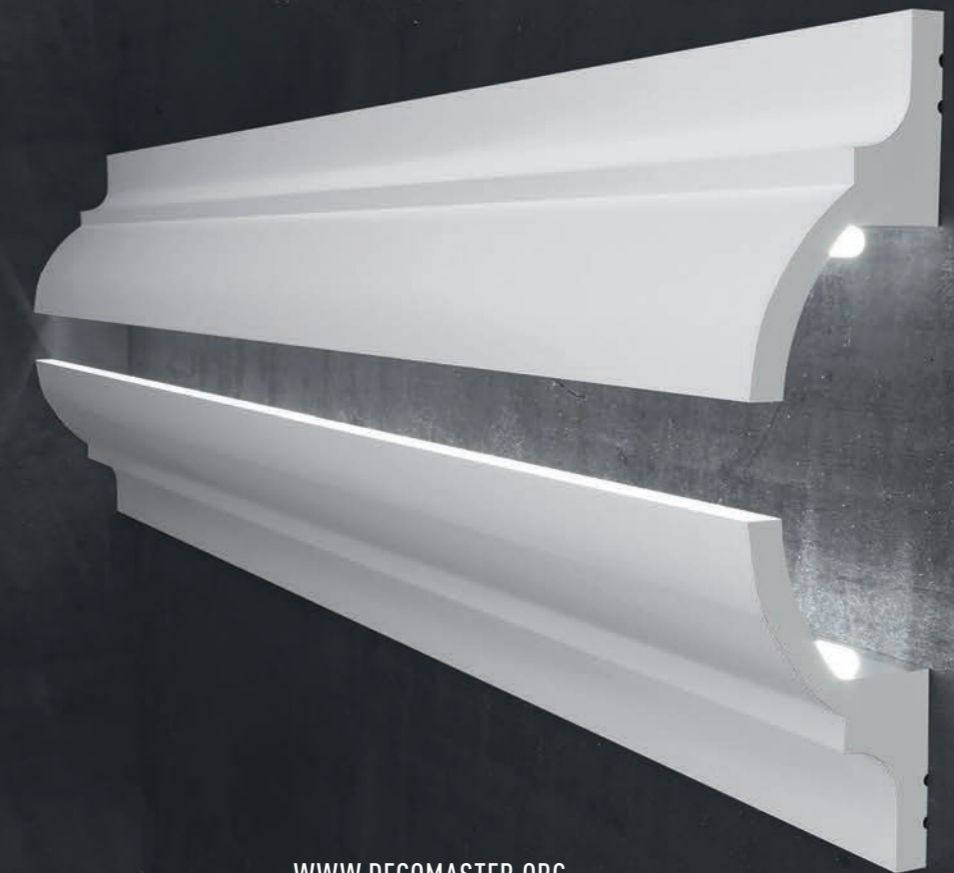
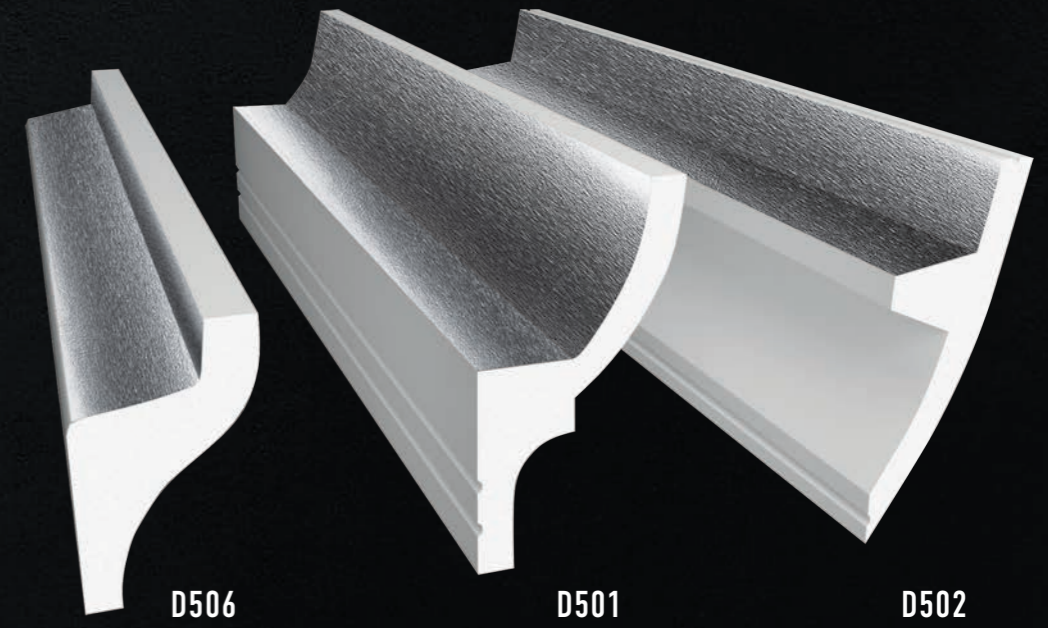



# DUROPROFILE COLLECTION ANGLE MOLDINGS

D135

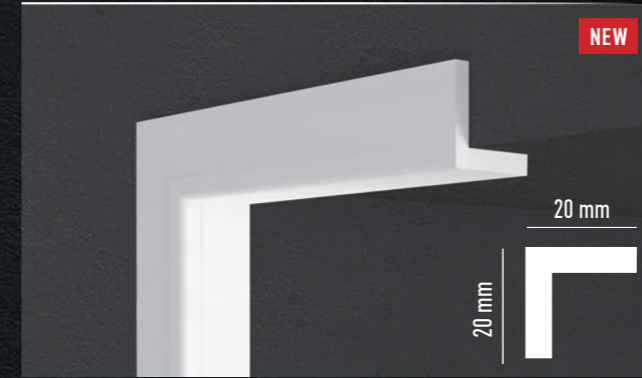

Length 2900 mm

D116M



D006



D116A



D134



D003



Angle molding D003

DUROPROFILE COLLECTION  
WALL MOLDINGS

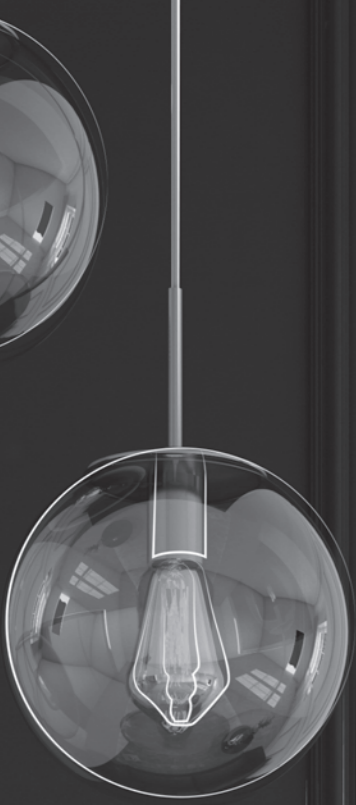

Length 2000 mm

D1137

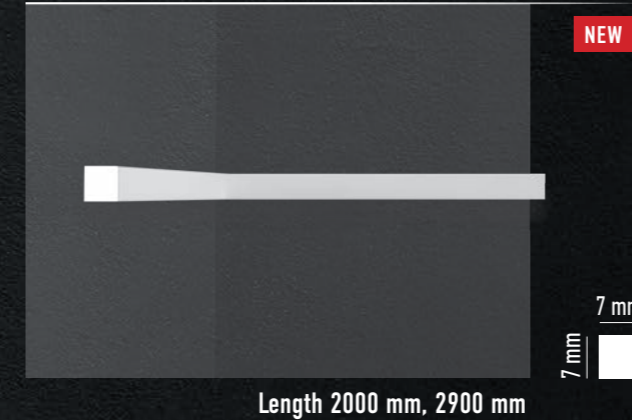

D130

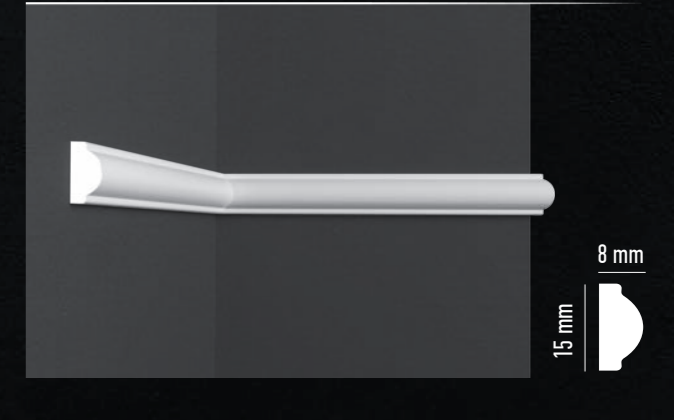

D160

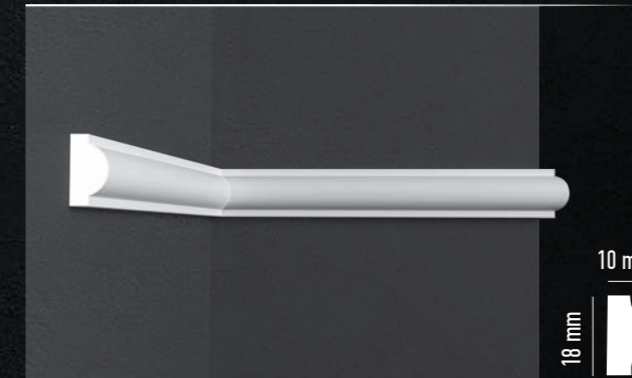

D007



D034

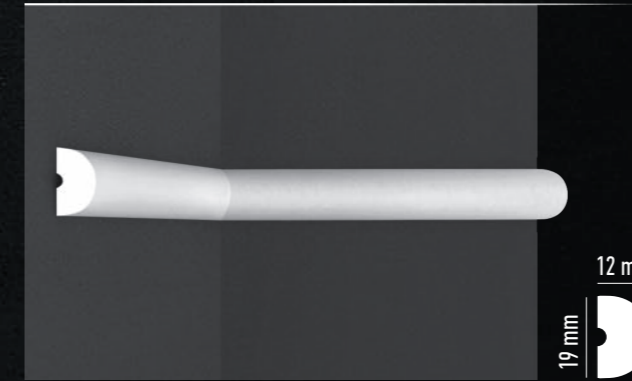

D047

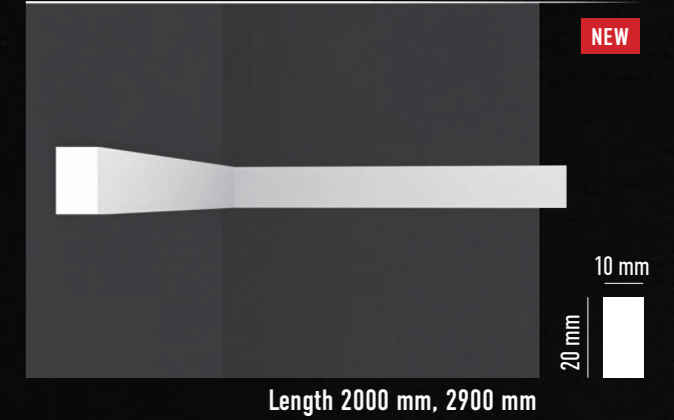

D046

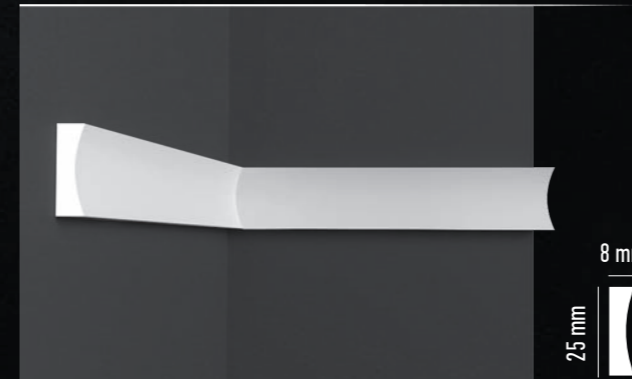

D001

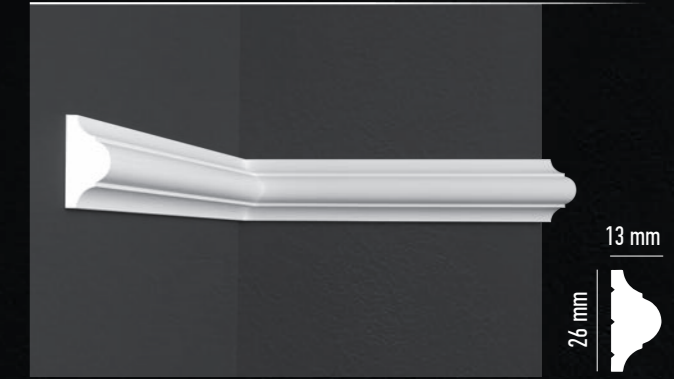



Length 2000 mm

D011

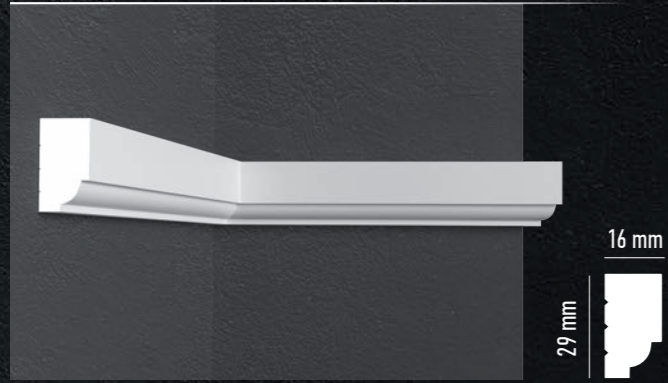

D1157

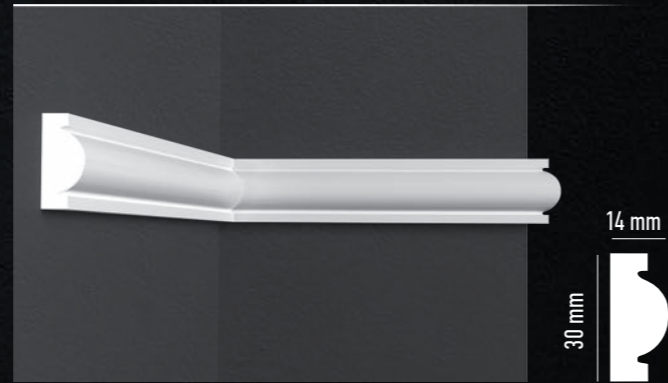

Length 2000 mm

D165

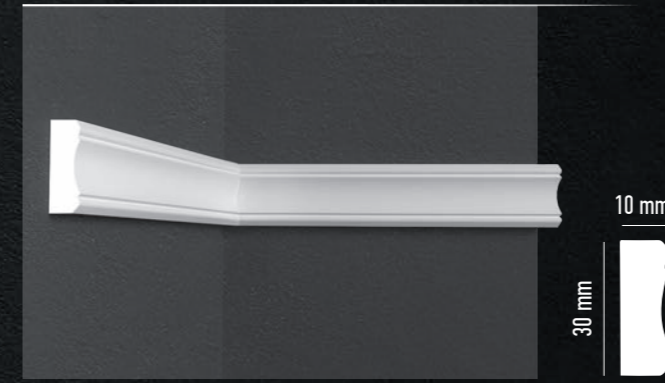

D048

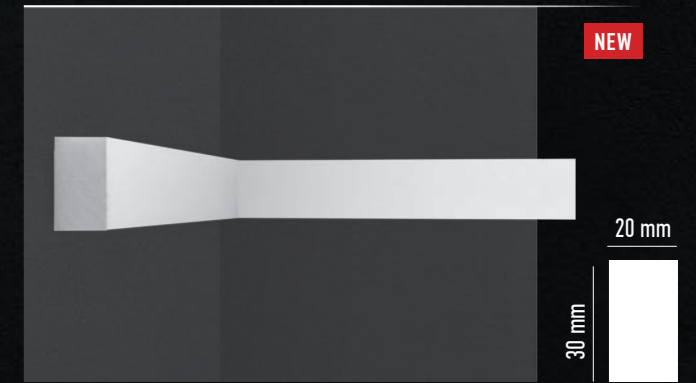

Length 2000 mm, 2900 mm

D116



D030

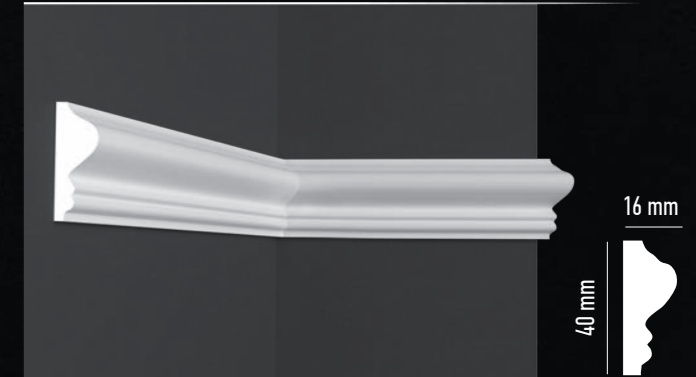

D002

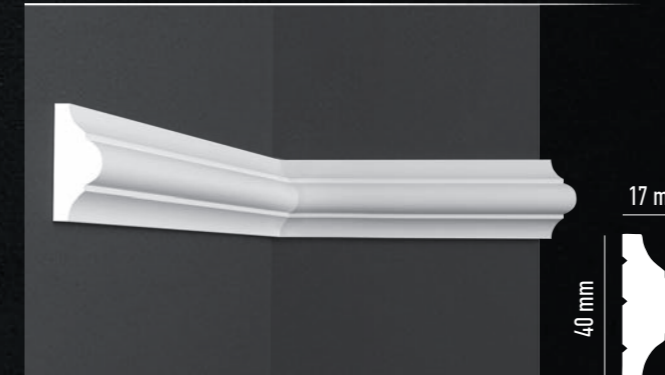

D161S

Suitable for stretch ceilings

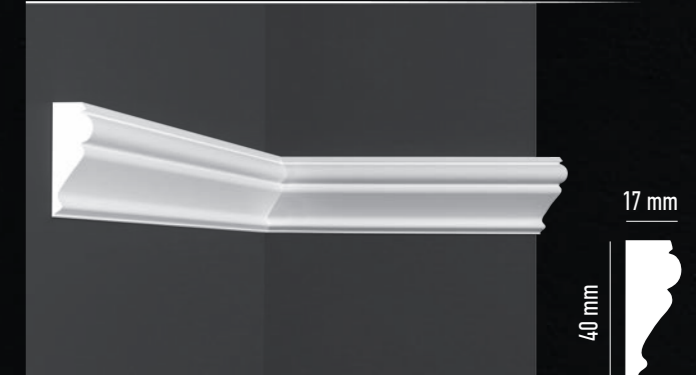

D507

Suitable for stretch ceilings

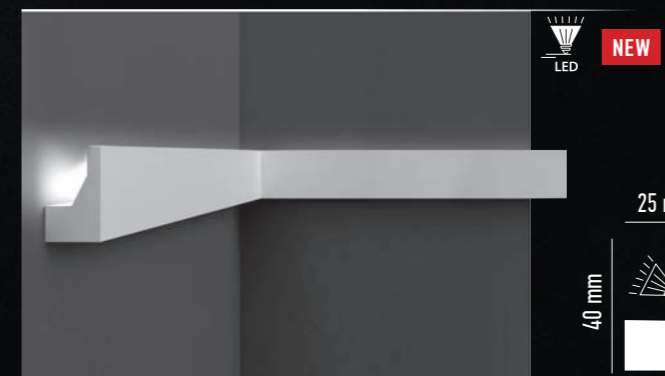

D162



Cornice D154

Molding D160



The project from TV program «Kvartirnyy vopros». Author - Irina Raikher.

Molding D048





Length 2000 mm

D144



D045

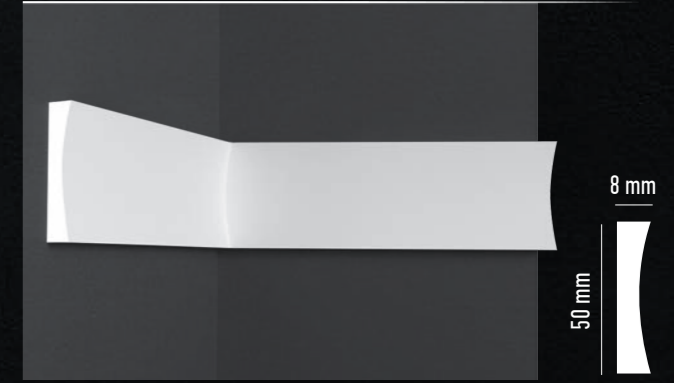

D156



D181

Suitable for stretch ceilings

NEW

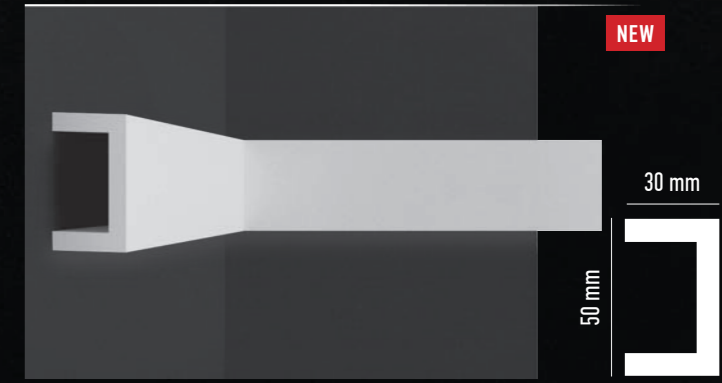

D161

Suitable for stretch ceilings

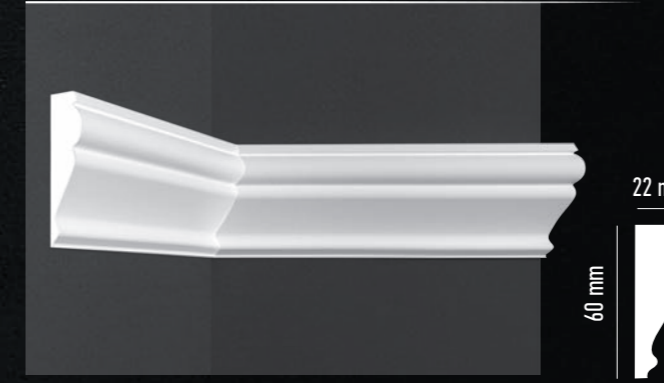

D228

Suitable for stretch ceilings

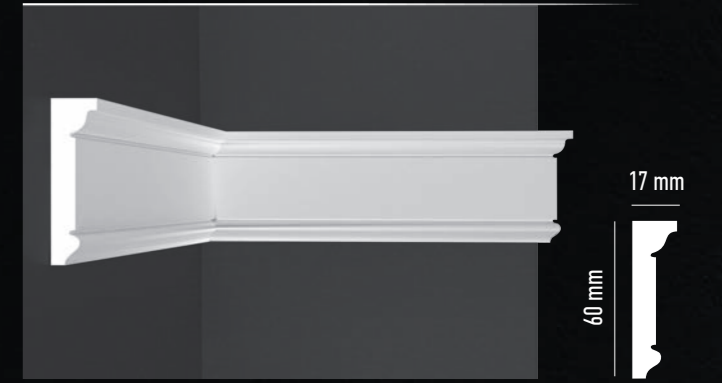

D022

Suitable for stretch ceilings

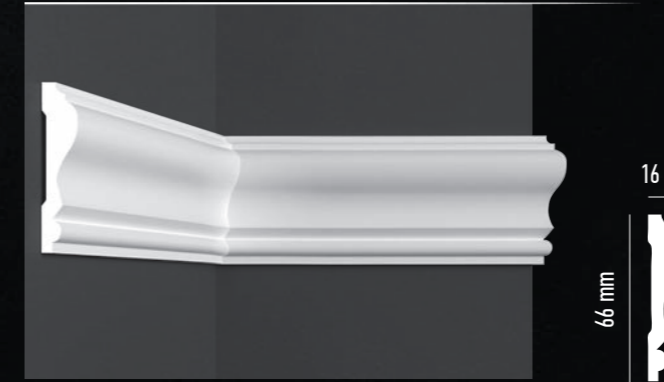

D150



D152

Suitable for stretch ceilings



D226

Suitable for stretch ceilings



D201

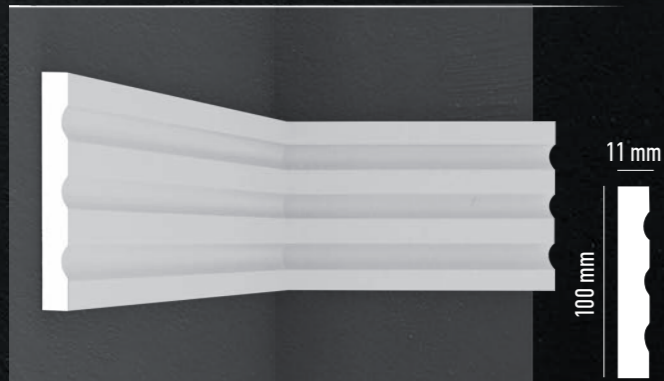

Length 2400 mm

D163

NEW

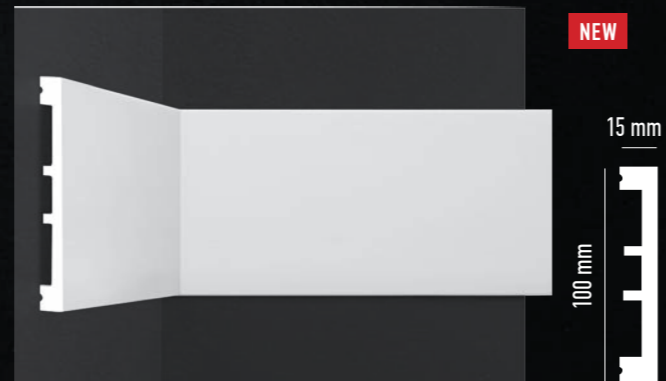

D227

Suitable for stretch ceilings



D225

Suitable for stretch ceilings



D301

NEW



Length 2000 mm, 2900 mm

D214

Suitable for stretch ceilings



# DUROPROFILE COLLECTION FLOOR SKIRTINGS



Length 2000 mm

D230



D231



D234



D157



D125



D193



D193A



D122



D005



D037

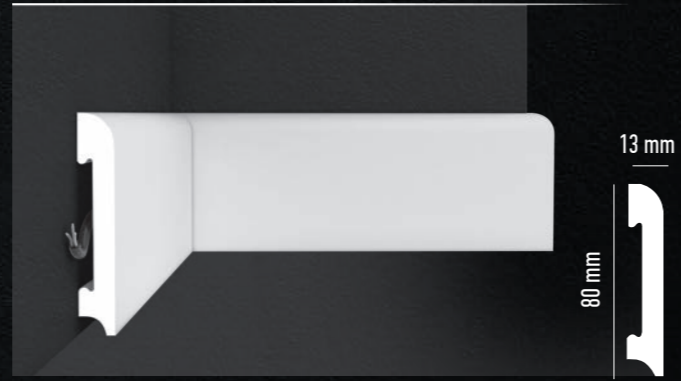

D036

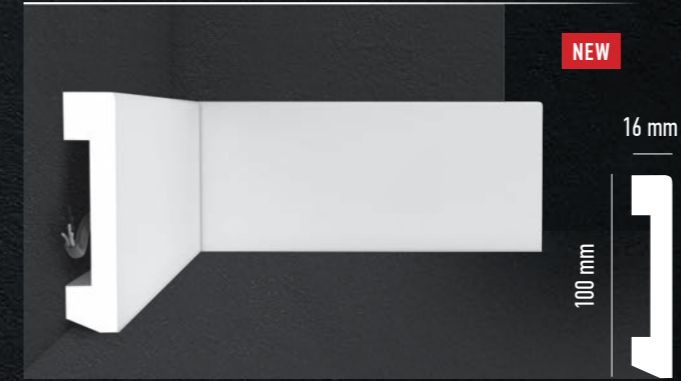

D171

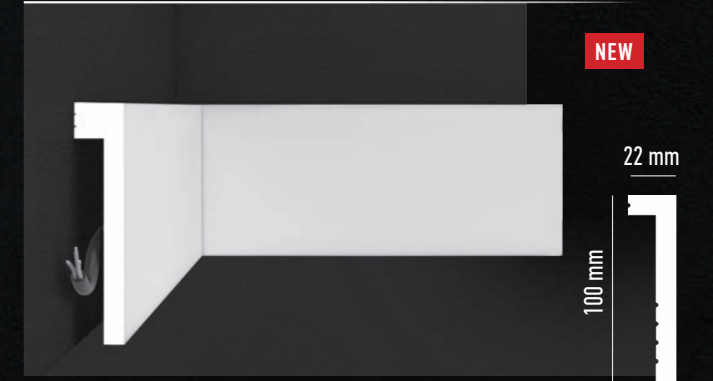

D235



D137

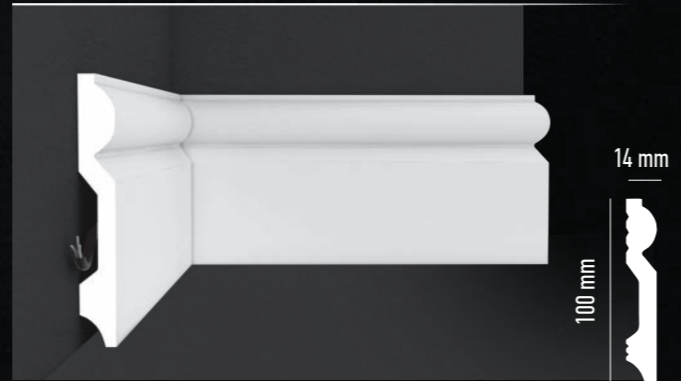

D232



D105

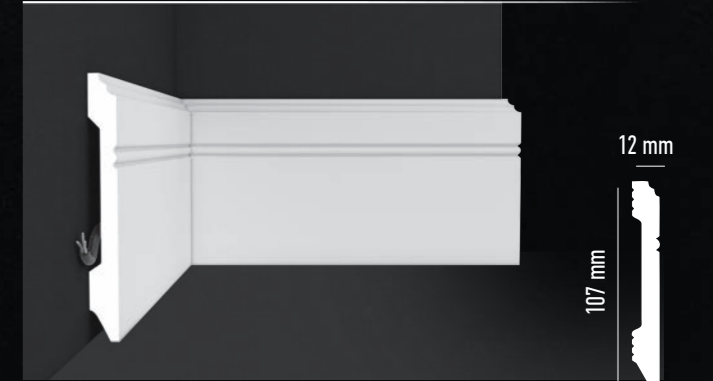

Length 2000 mm

Length 2000 mm

D004

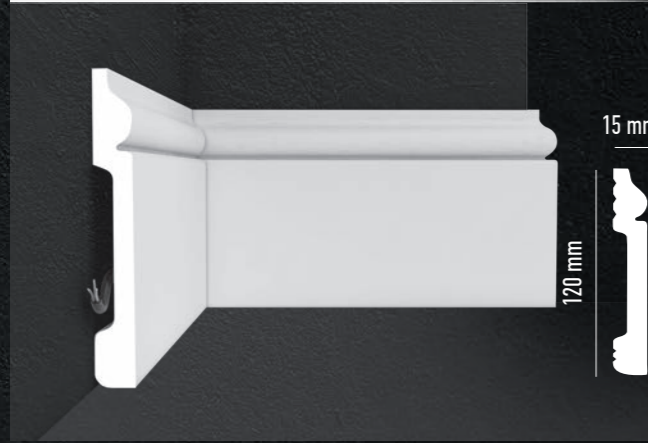

D233



D118

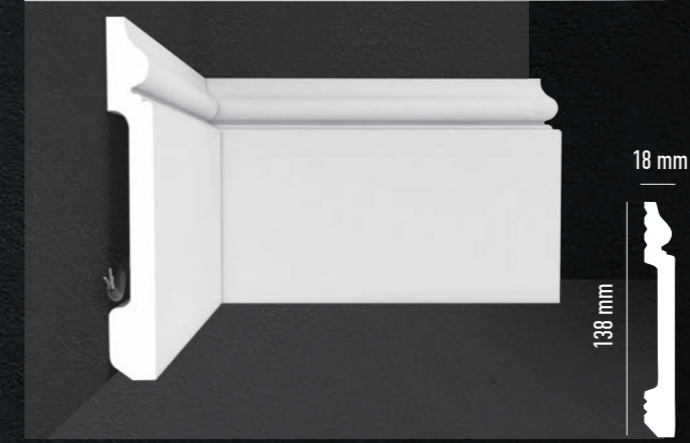

D104





# DUROPROFILE COLLECTION CORNICES WITH PATTERN

Length 2000 mm

DUROPROFILE - CORNICES WITH PATTERN

D148A



D148B

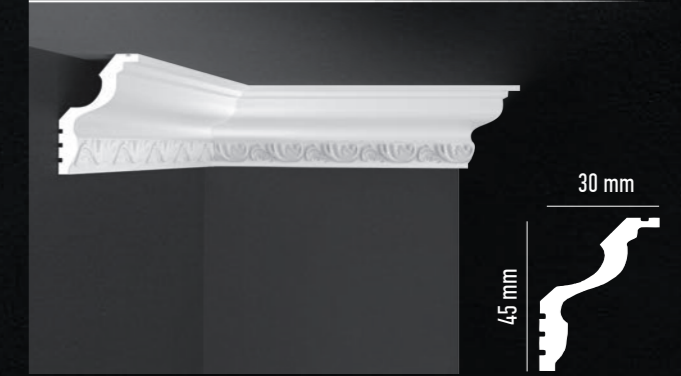

D155A



D155B



D100A



D100B



D154A



D154B





Cornice D155B

Molding  
с рисунком  
D150B



**DUROPROFILE COLLECTION  
WALL MOLDINGS WITH PATTERN**

Length 2000 mm

**D130A**

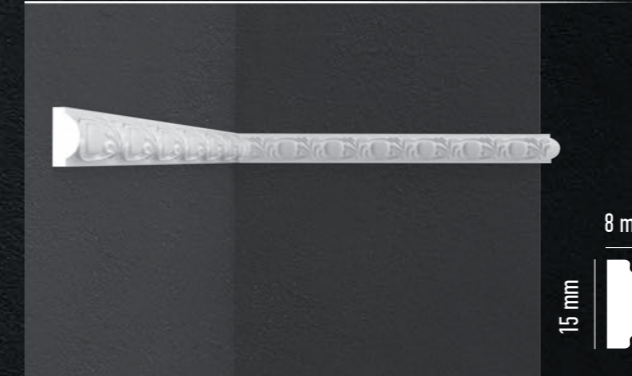

**D130B**



**D130D**

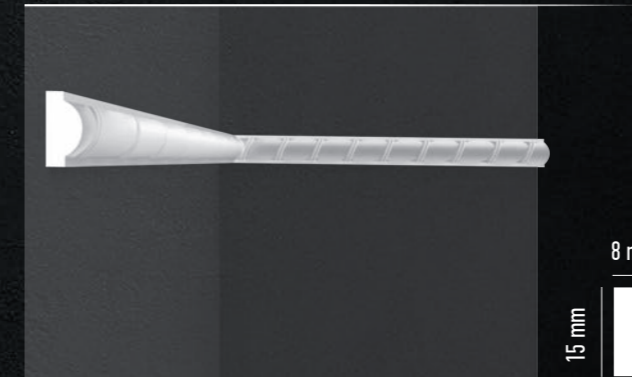

**D103A**

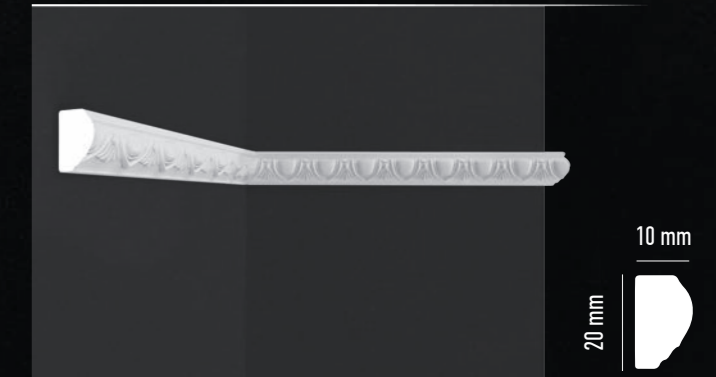

**D103B**



**D128**



**D1157A**

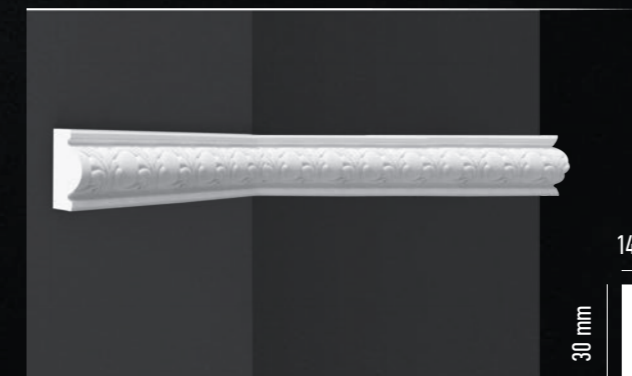

**D1157B**



Length 2000 mm

D044

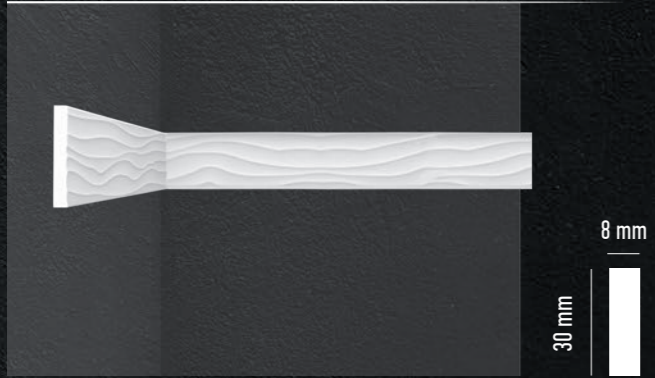

D101A

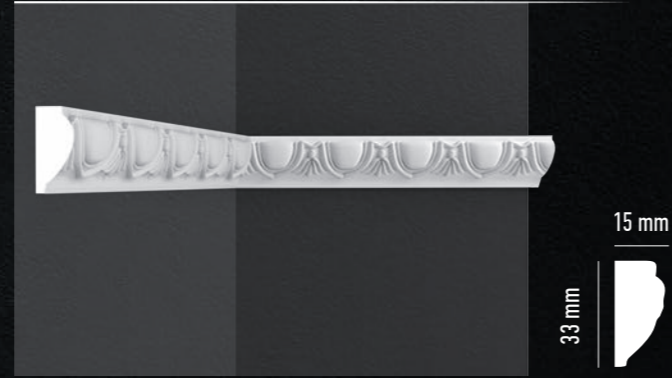

D101B

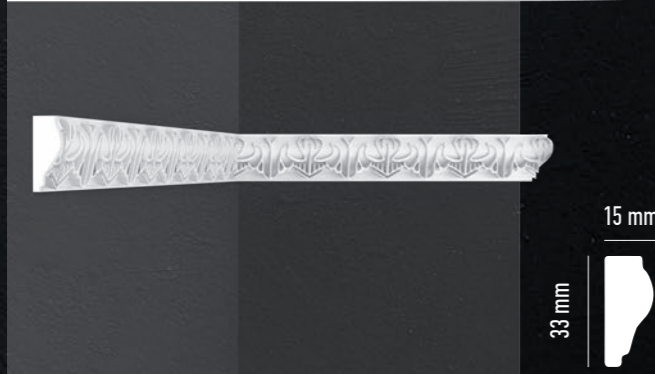

D101C



Length 2000 mm

D156A



D156B



D161A

Suitable for stretch ceilings

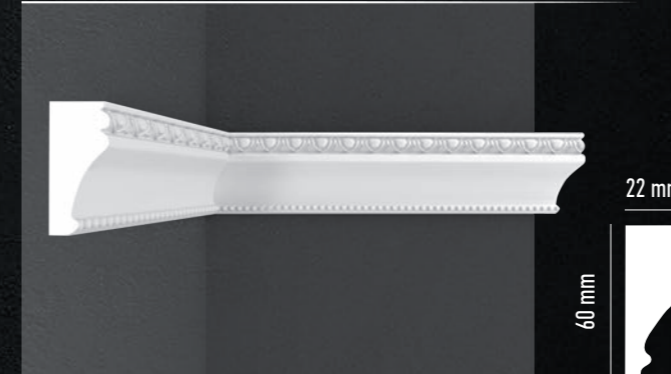

D161B



D161D



D219

Suitable for stretch ceilings

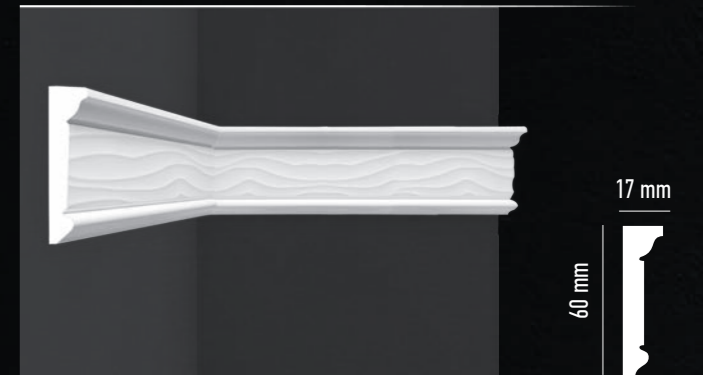

D043

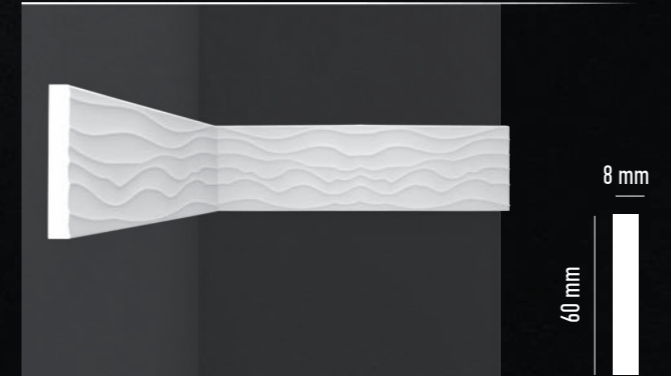

D042

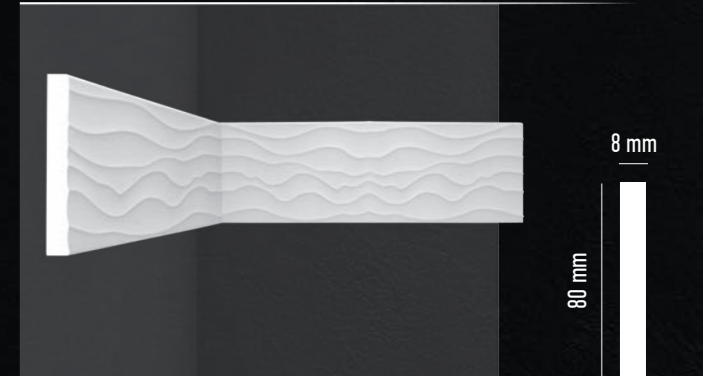

Molding D130D

Molding D045

Molding D219

Molding D046

Molding D043

Molding D044

Molding D043

Floor skirting D227

**D150A**



**D150B**



**D152A**

Suitable for stretch ceilings



**D152B**

Suitable for stretch ceilings



**D226A**

Suitable for stretch ceilings



**D226B**

Suitable for stretch ceilings



**D225B**

Suitable for stretch ceilings



**D214A**

Suitable for stretch ceilings



**D218**

Suitable for stretch ceilings

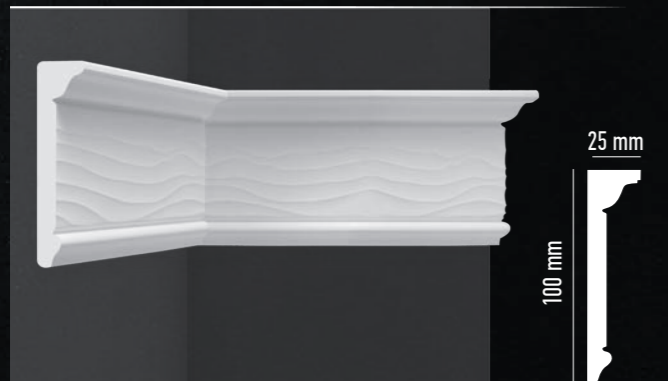

**D225A**

Suitable for stretch ceilings



**D214B**

Suitable for stretch ceilings





ART DECO

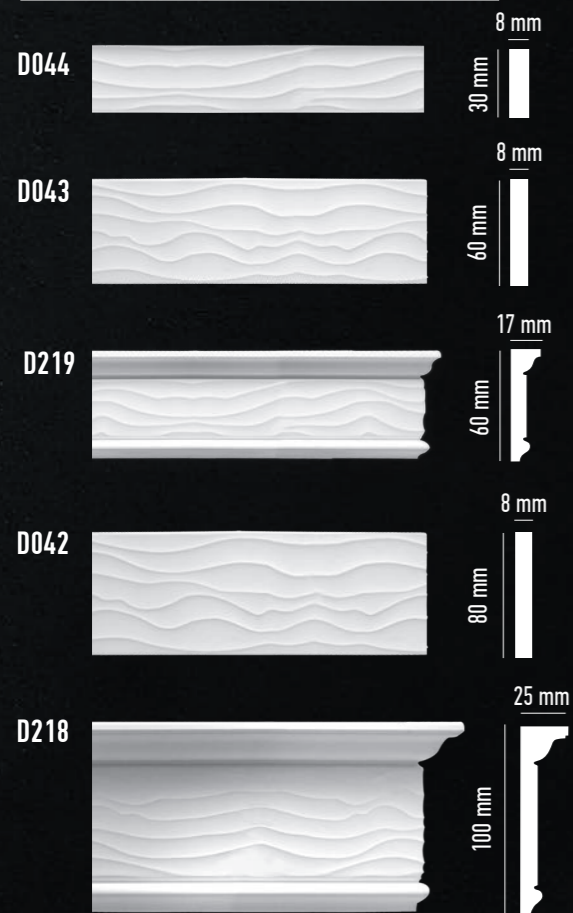



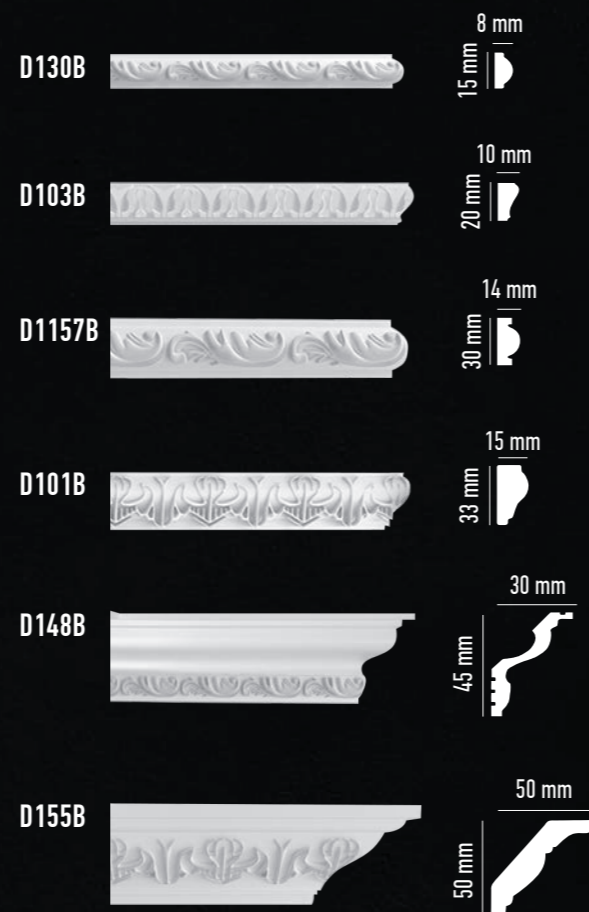













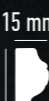











HERMITAGE





IONIKA

D130A		8 mm 15 mm		D161A		22 mm 60 mm	
D103A		10 mm 20 mm		D100A		69 mm	
D128		15 mm 27 mm		D154A		77 mm	
D1157A		14 mm 30 mm		D152A		25 mm 85 mm	
D148A		30 mm 45 mm		D226A		20 mm 90 mm	
D155A		50 mm 50 mm		D225A		29 mm 110 mm	
D156A		11 mm 50 mm		D214A		38 mm 150 mm	
D161D		17 mm 60 mm					

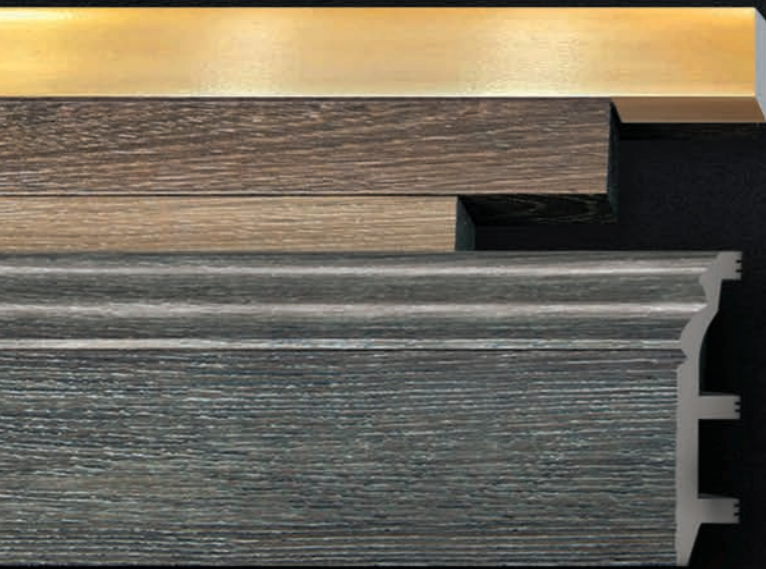

Scan QR code  
and download the collection  
ECO LINE DECOMASTER



Scan QR code  
and download the collection  
COLOR MOLDINGS DECOMASTER



Scan QR code  
and download the collection  
SKIRTING BOARDS DECOMASTER





Molding D201

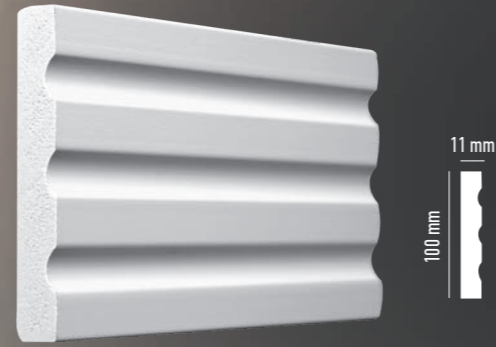

Molding D201

Cornice D501

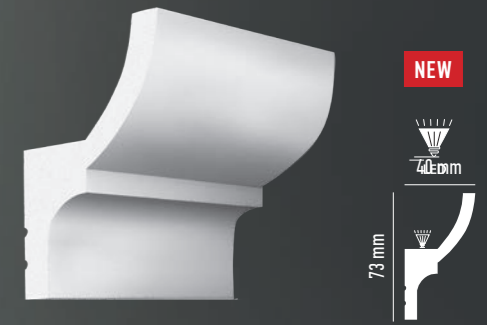

Cornice D501

Molding D116

Floor skirting D235

Floor skirting D235

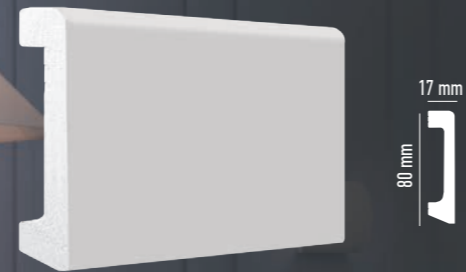

Floor skirting D235

Molding with pattern D150B

Molding D227

Molding D227

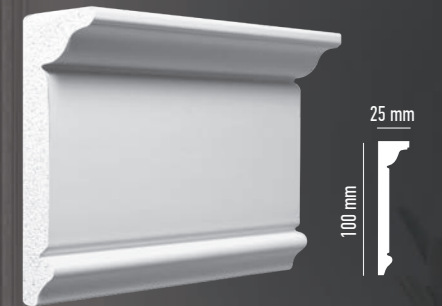

Molding D227

Molding with pattern D150B

Molding D116

High tech



Modern

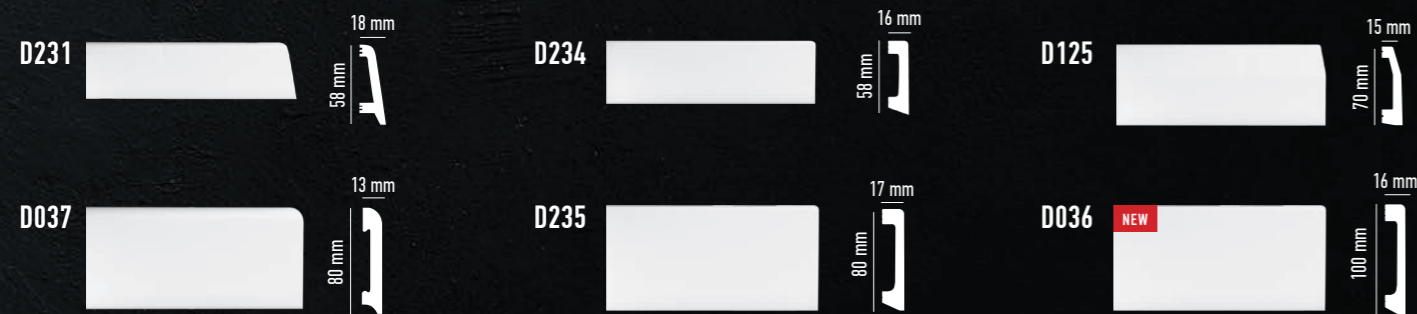

Neoclassic

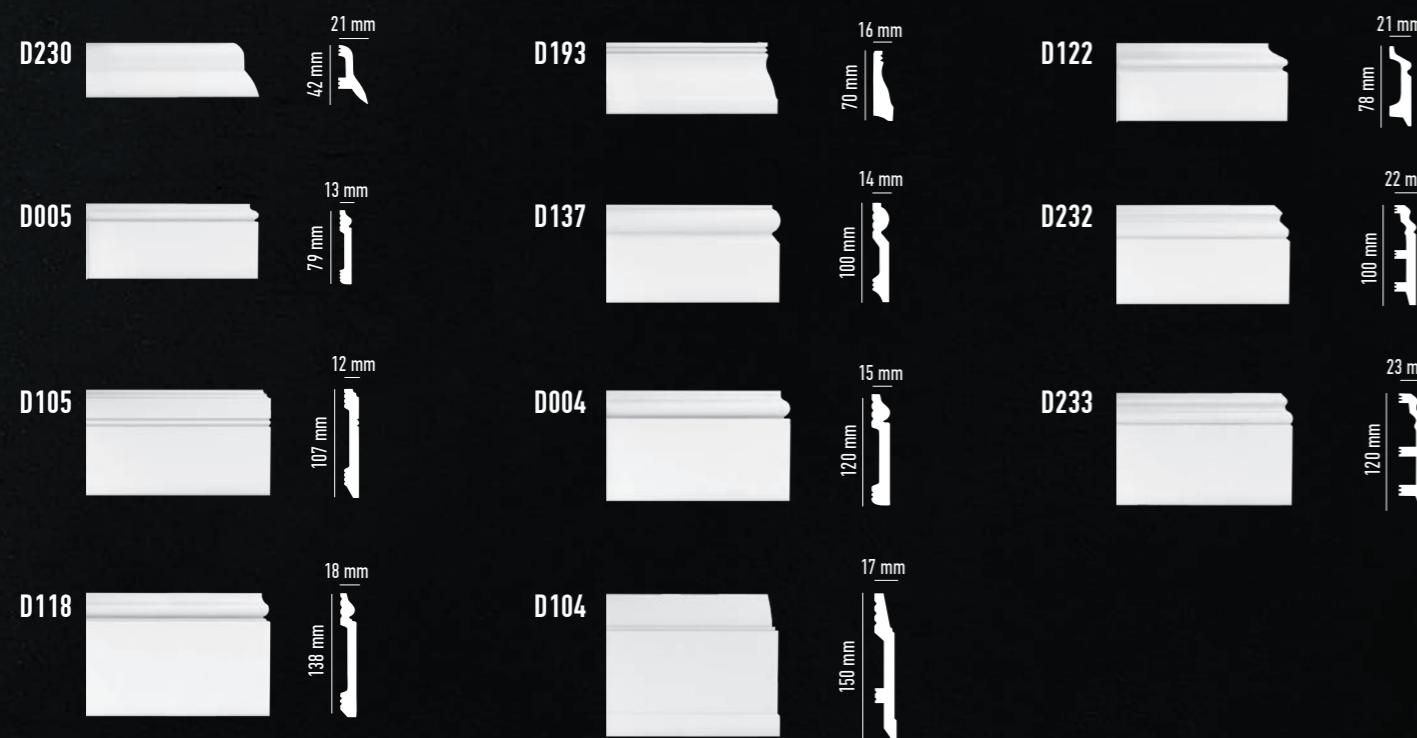

Cornices

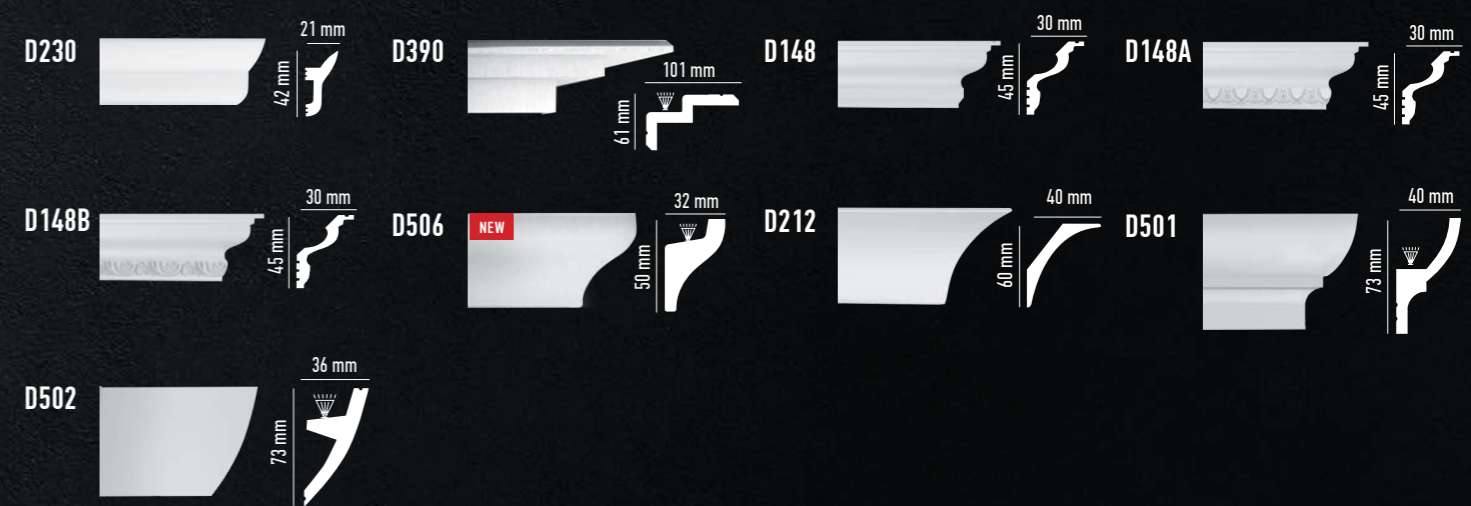

Moldings





Cornice D506

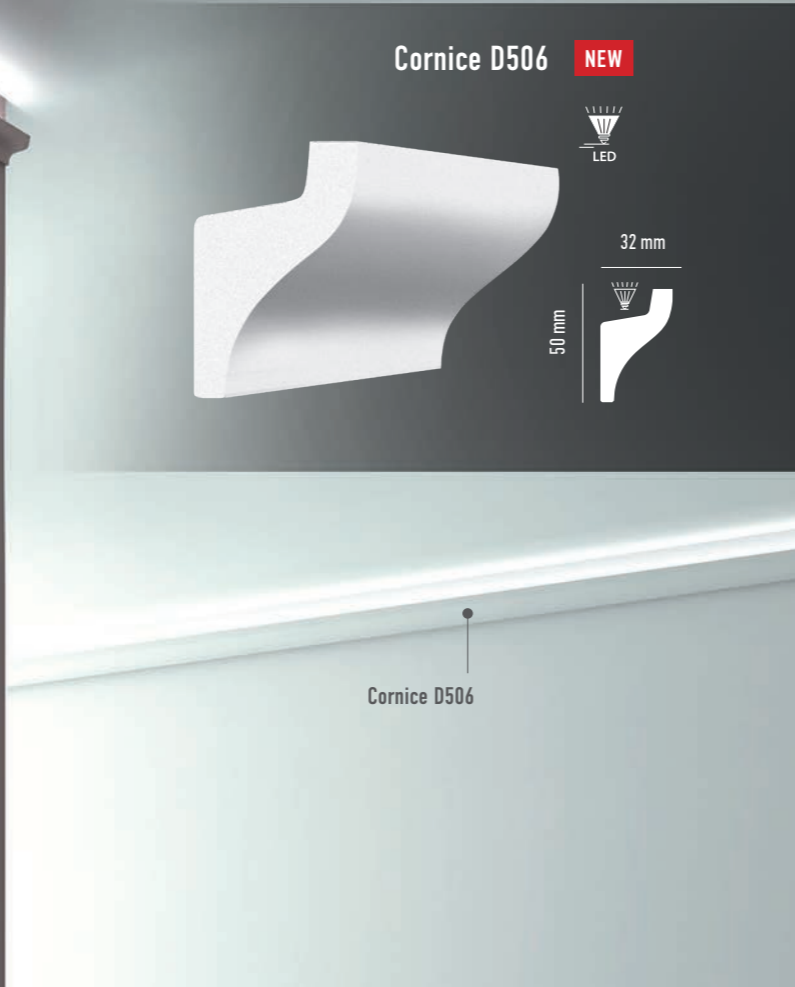

Cornice D506



Molding with pattern D225B

Cornices

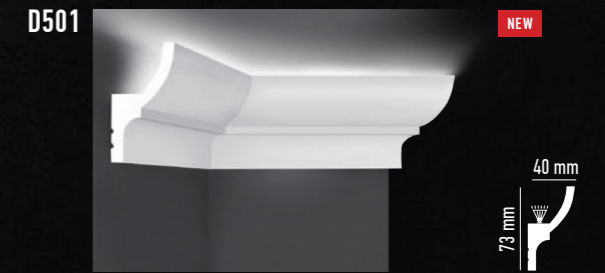

Moldings

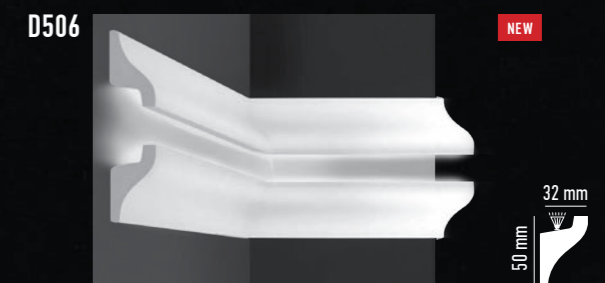
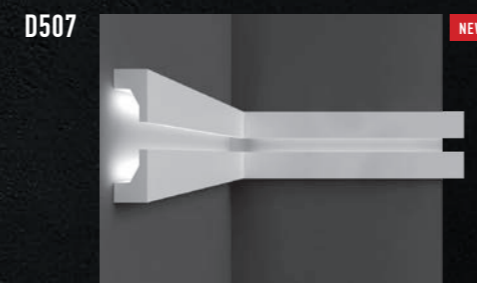

Floor skirtings

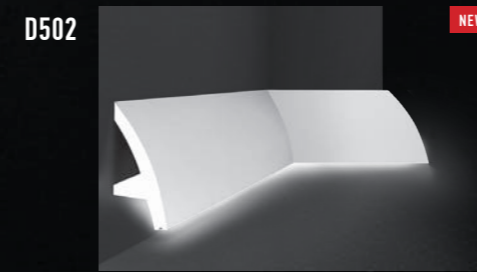

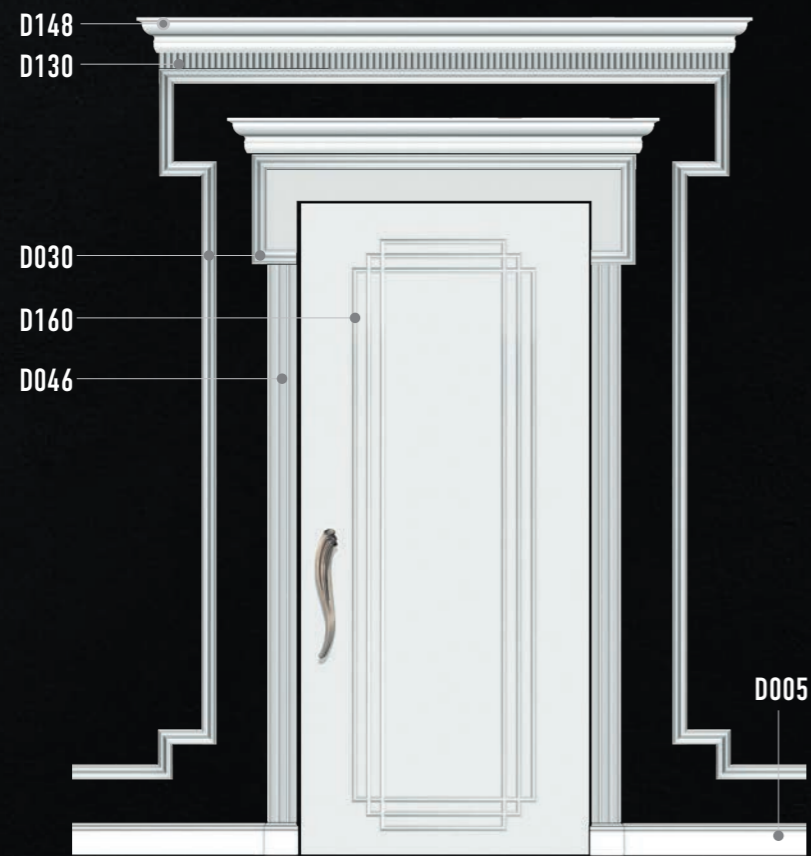

DECOMASTER products are made from impact-resistant polymer, a durable material that does not break, does not crumble and loves water. DECOMASTER products easy to install following a simple instruction.

**Storage and installation conditions**

Do not allow sudden changes in temperature and humidity between storage and installation. Store profiles and adhesive in normal room temperature for 24 hours before installing.



**Preparation**

Skirting are installed directly at the joint of the floor and the wall. Carefully flat the walls and the floor.

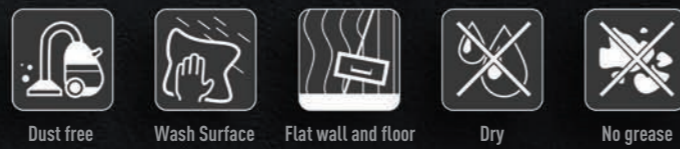

**STEP 1**  
Measure inside corner.

**STEP 2**  
Use precision mitre saw or hacksaw for make an incision. Please note that saw blade must have a minimum sized teeth (for ex., aluminum disc).

**STEP 3**  
Apply glue evenly on installation side over the entire length. Use Decomaster adhesive «Монтаж-Декор» for best results. The thickness of the applied adhesive layer will be 3 - 5 mm.

**STEP 4**  
Push firmly over the entire length.

**STEP 5**  
Remove excess adhesive in joints with spatula after max/1hr, repeat after 2-3 hours.

**STEP 6**  
If necessary, remove excess adhesive from the product and from the junction with the wall with a cloth and soapy water or solvent.

**STEP 7**  
Apply instant action glue or «Монтаж-Декор» adhesive to the edge of the products.

**STEP 8**  
Held firmly in every joint. Push firmly to the wall over the entire length. You can correct the joint if you use adhesive «Монтаж-Декор», and you can't correct if you use instant action glue.

**STEP 9**  
Remove excess glue from joints with spatula after max 1hr, repeat after 2-3 hrs.

**STEP 10**  
If necessary clean with Acetone or soapy water.

**STEP 11**  
Apply by brush, roller or airbrush following the paint manufacturer's instructions.



Scan QR-code and get more information about installation of cornice for painting



Scan QR-code and get more information about installation of molding for painting



Scan QR-code and get more information about installation of floor skirting for painting

Solution №1



STEP 1

Measure the required length of the floor skirting and mark the cut place.

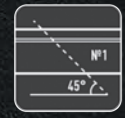

STEP 2

Place the floor skirting horizontally and make the first cut at the 45° mark. Set piece №1 aside.

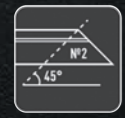

STEP 3

Rotate the saw around and make a 45° cut as shown in the picture. Item №2 is no longer needed.



STEP 4

Rotate the saw 90° and cut as shown at the picture.



STEP 5

Apply glue evenly on part №1 and stick to the wall in accordance with the installation instructions.



STEP 6

Apply glue evenly on part №3 and stick to the wall as shown in the picture. Parts №1 and №3 are glued together with DECOMASTER instant action glue.



STEP 7

Remove excess glue from joints with spatula after max 1hr, repeat after 2-3 hrs.



STEP 8

If necessary clean with Acetone or soapy water.

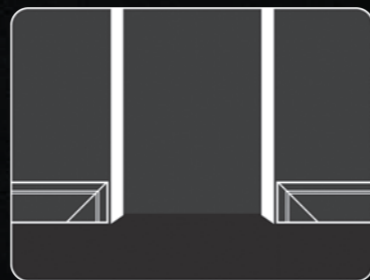

Solution №2



STEP 1

Measure the required length of the floor skirting and mark the cut place.



STEP 2

Place the floor skirting vertically and make the first cut at the 45° mark. Set piece №1 aside.



STEP 3

Rotate the saw around and make a 45° cut as shown in the picture. Item №2 is no longer needed.



STEP 4

Rotate the saw 90° and cut as shown in the picture.



STEP 5

Apply glue evenly on part №1 and stick to the wall in accordance with the installation instructions.



STEP 6

Apply glue evenly on part №3 and stick to the wall as shown in the picture. Parts №1 and №3 are glued together with DECOMASTER instant action glue.



STEP 7

Remove excess glue from joints with spatula after max 1hr, repeat after 2-3 hrs.



STEP 8

If necessary clean with Acetone or soapy water.

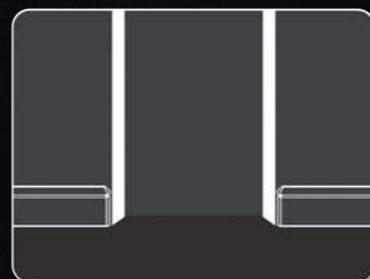
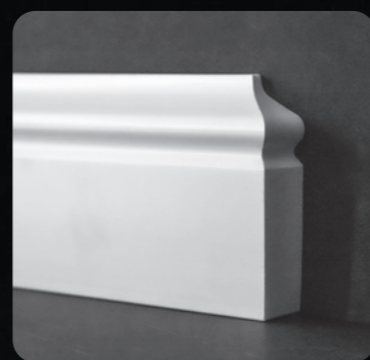

ADHESIVE-SEALANT “Монтаж-Декор”

Professional sealant with high initial adhesion.

- Can be used to any surface.
- Elastic after complete drying, resistant to vibration.
- 30 minutes time of adjustment.
- Fungus and mold resistant. Can be used in WC, bathrooms and kitchens.
- Odorless.
- Water-resistant, weather-resistant from -40 to + 90°C and UV-resistant after drying.

Additional:

The adhesive sealant is elastic and does not use as a preparation of joints for painting. For filling joints between moldings please use special fillers glue (only for products for painting).

The glue defrosted at room temperature without intense heating (i.e., you cannot use a hair dryer, radiators, etc.).



DECOMASTER INSTANT ACTION GLUE

Cyanoacrylate instant action adhesive.

Due to structure, the adhesive allows you to carefully glue various surfaces without smudges and spreading. Particularly suitable for bonding uneven or porous surfaces with excellent occupancy.

Advantages:

- Quickly sets and dries.
- Provide mechanical strength to the joint.
- Water-resistant, UV-resistant and frost-resistant.
- Setting time up to 1 min.
- Complete drying time up to 10 minutes.

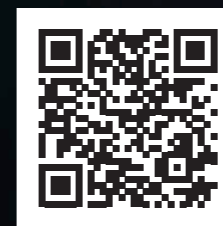

Scan QR code and get more information about assortment glue Decomaster





ITEM	PAGE	ITEM	PAGE	ITEM	PAGE
D001	15	D116	17	D161B	37
D002	17	D116A	13	D161D	37
D003	13	D116M	13	D161S	17
D004	28	D118	29	D162	17
D005	26	D122	25	D163	22
D006	13	D124	8	D165	17
D007	15	D125	25	D171	27
D008	7	D128	35	D181	21
D011	16	D130	15	D193	25
D022	21	D130A	35	D193A	25
D030	17	D130B	35	D201	22
D034	15	D130D	35	D212	9
D036	27	D132	7	D214	22
D037	26	D133	7	D214A	41
D042	37	D134	13	D214B	41
D043	37	D135	13	D218	40
D044	36	D137	26	D219	37
D045	21	D144	21	D225	22
D046	15	D148	8	D225A	40
D047	15	D148A	31	D225B	41
D048	17	D148B	31	D226	22
D100	10	D150	21	D226A	40
D100A	31	D150A	40	D226B	40
D100B	31	D150B	40	D227	22
D101A	36	D151	7	D228	21
D101B	36	D152	22	D230	25
D101C	36	D152A	40	D231	25
D103A	35	D152B	40	D232	27
D103B	35	D154	10	D233	28
D104	29	D154A	31	D234	25
D105	27	D154B	31	D235	26
D108	9	D155	8	D301	22
D109	7	D155A	31	D390	9
D110	7	D155B	31	D501	10
D111	7	D156	21	D502	10
D112	9	D156A	37	D506	8
D115	7	D156B	37	D507	17
D1137	15	D157	25		
D1157	16	D160	15		
D1157A	35	D161	21		
D1157B	35	D161A	37		

[www.decomaster.org](http://www.decomaster.org)

 [t.me/decomaster\\_su](https://t.me/decomaster_su)

 [vk.com/decomaster\\_official](https://vk.com/decomaster_official)

 [zen.yandex.ru/decomaster](https://zen.yandex.ru/decomaster)